

BC H9Gfl B @9GC Hk 9FK 69GD97 ÷ 98L  
 %'6F95? '5@@G<5FD'98; 9G  
 &"F9A C J 9'5@6l FFG: C F'G5: 9'<5B8@B;

**F9J 6CBG**

97F	F9J 6CB	89G7 F DHC B	7<5B: 98'6M	85H9	5DDFC J 98'6M
9B;	%	B9K F9@95G9	76	(#%+##&\$&\$)	FH

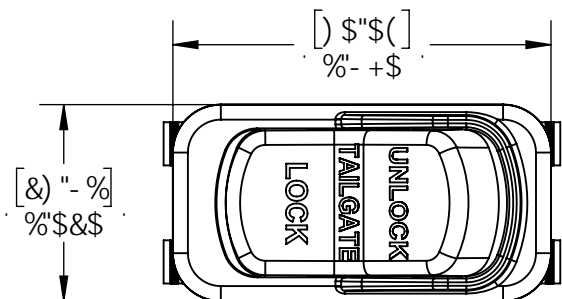

DF BH@; C  
 5B8 D5FHBI A 69F  
 C B GK #7 <

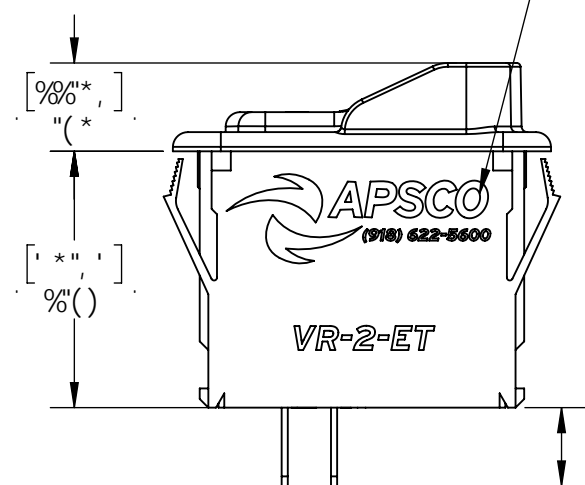

"& \$ L '\$' &  
 0'" ) Q'Q, %Q

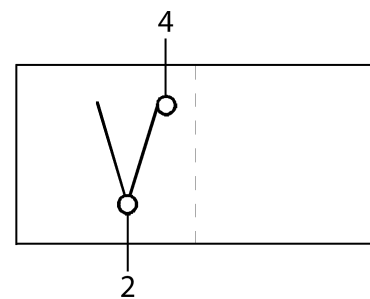
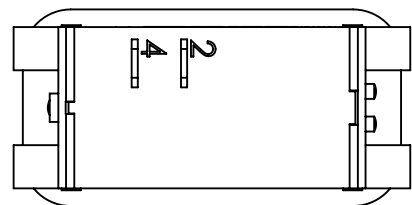
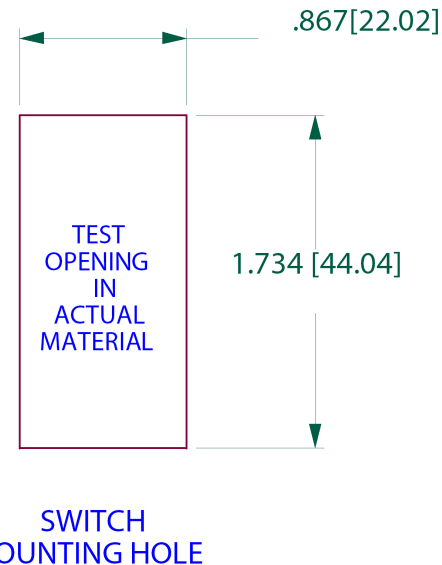
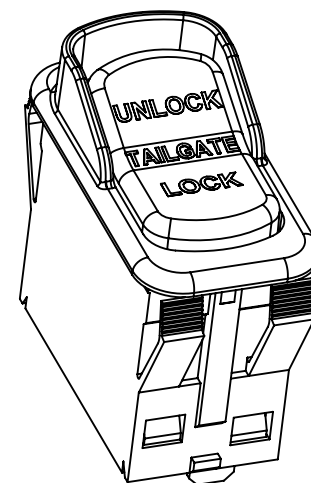
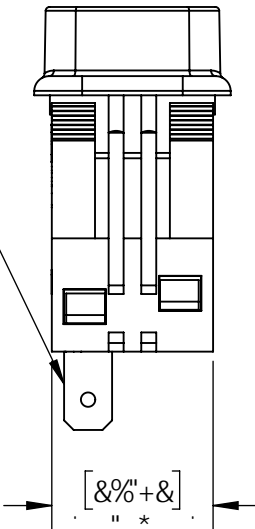

CIRCUIT DIAGRAM

<p><b>DFCDF 9H5 FM5 B8 7 CB: 89BH5 @</b>          VP O A Q U T C V Q P A O U P V C P O O A P Q U O C Y Q O A P O A          U U S O A U U U O U V Y A U O 5 DG7 C b W A P Y A U O U U O W O N P A C A          U C E V A U A E U A Z Y P U S O A Q P U W A Y U Q V O P A U O U T Q U W P A U O A  <b>5 DG7 C b W A U A U U P Q Q O O E</b></p>		<p><b>5 DG7 C</b>          , % , ' 95 GH' ( H &lt; ' GHF99H          H I @ 35 Z C ? ' + ( % )          fl % L * &amp; &amp; ) * \$ \$</p>	
<p>HMD9C: DFC &gt;97 HC B            Hk F8 5B: @9DFC &gt;97 HC B</p>		<p>A 5HF5@          B#5</p>	
<p>8F5K B  <b>76</b>          7&lt;97798</p>	<p>85H9          ( # % + # &amp; \$ &amp; \$ )          85H9          ( # % + # &amp; \$ &amp; \$ )</p>	<p>H#09. GK #7 &lt; '9@97 HF 7 'H5 @ 5H9</p>	
<p>5DDFC J 98          ?H          :B5@          FH</p>	<p>85H9          ( # % + # &amp; \$ &amp; \$ )          85H9          ( # % + # &amp; \$ &amp; \$ )          85H9          ( # % + # &amp; \$ &amp; \$ )</p>	<p>I B @9GC Hk 9FK 69GD97 ÷ 98          8 A 9BGC BG5F9'B 7 &lt; 9G          HC @F5B7 9G5F9.          897 A 5@ G F: 579: B 6&lt; . *          "L 1" ± "\$" 5B: @G ± &amp; *          "LL 1" ± "\$" &lt; C @G ± "\$\$)          "LLL 1" ± "\$%" &lt; C @G @C 7 5HC B ± "\$\$)</p>	
<p>8K ; "'BC"  <b>J F ! &amp; ! 9H</b></p>		<p>G&lt;99HGAP  <b>Ó</b></p>	<p>G7 5 @  <b>FK</b></p>
<p>#B: J F ! &amp; ! 9H</p>		<p>G&lt;H' % C : %</p>	