

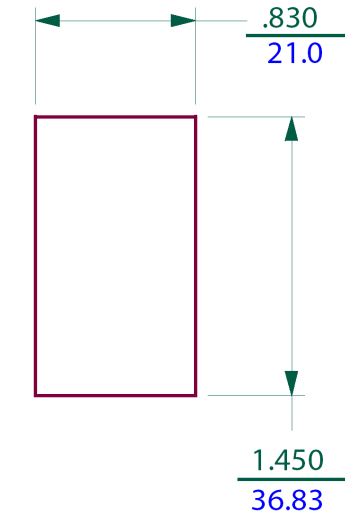

NOTES (UNLESS OTHERWISE SPECIFIED)
 1. BREAK ALL SHARP EDGES
 2. REMOVE ALL BURRS FOR SAFE HANDLING

REVISIONS					
ECR	REVISION	DESCRIPTION	CHANGED BY	DATE	APPROVED BY
ENG	1	NEW RELEASE	CB	5/7/2020	RT

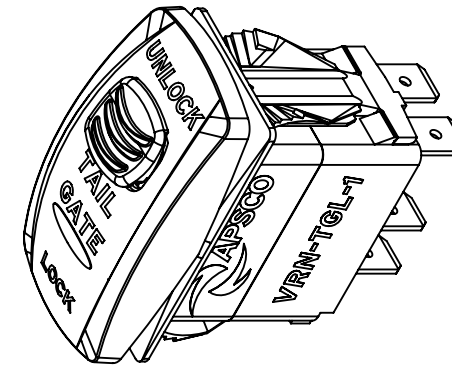
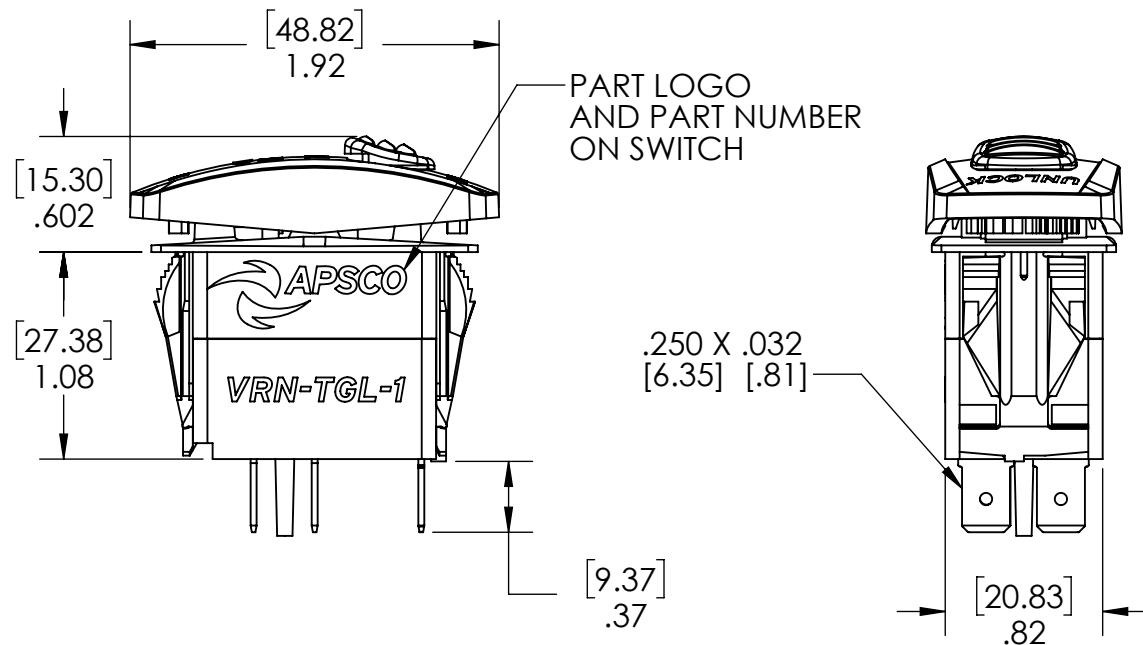
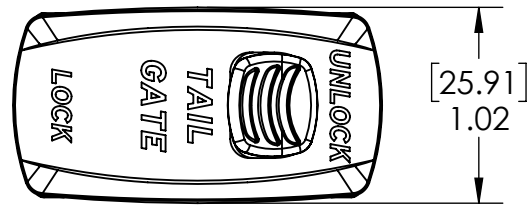
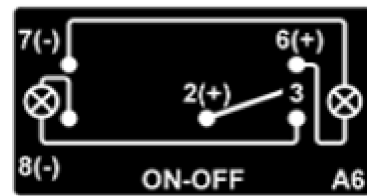
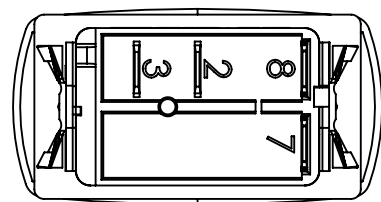

MOUNTING HOLE
 PANEL THICKNESS
 (SNAP - IN BRACKET)
 .030 MIN --- .187 MAX
 .76 4.75



PROPRIETARY AND CONFIDENTIAL THE INFORMATION CONTAINED IN THIS DRAWING IS THE SOLE PROPERTY OF APSCO Inc.. ANY REPRODUCTION IN PART OR AS A WHOLE WITHOUT WRITTEN PERMISSION OF APSCO Inc. IS PROHIBITED.		 8178 EAST 44TH STREET TULSA, OK 74145 (918) 622-5600	
TYPE OF PROJECTION  THIRD ANGLE PROJECTION	MATERIAL N/A	TITLE: TAILGATE SLIDE LOCK SWITCH LIGHTED	
DRAWN CB DATE 5/7/2020	CHECKED DB DATE 5/7/2020	APPROVED KT DATE 5/7/2020	FINAL RT DATE 5/7/2020
FINISH N/A		UNLESS OTHERWISE SPECIFIED DIMENSIONS ARE IN INCHES TOLERANCES ARE: DECIMALS .X = ±.06 .XX = ±.03 .XXX = ±.010 SURFACE FINISH: 63 ANGLES ± 2° HOLES ± .005 HOLES LOCATION ± .005 DO NOT SCALE DRAWING	DWG. NO. VRN-TGL-1 SHEET SIZE B SCALE 1:1 REVISION 1
F/N: VRN-TGL-1			SHT. 1 OF 1